

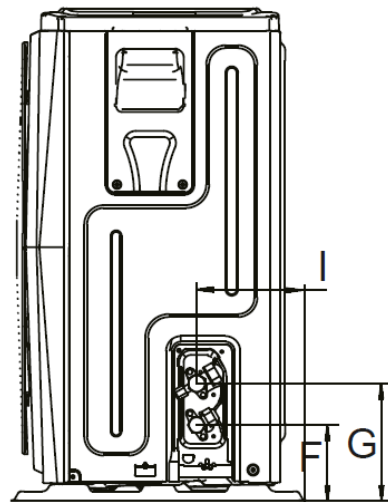

Luft- Wasser- Wärmepumpe Super Inverter WMT6000

Aussengerät WMT6000

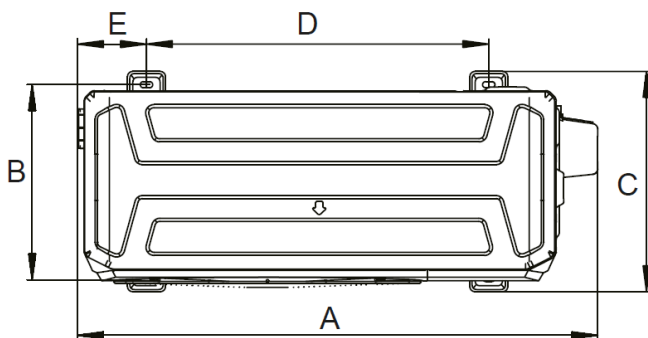
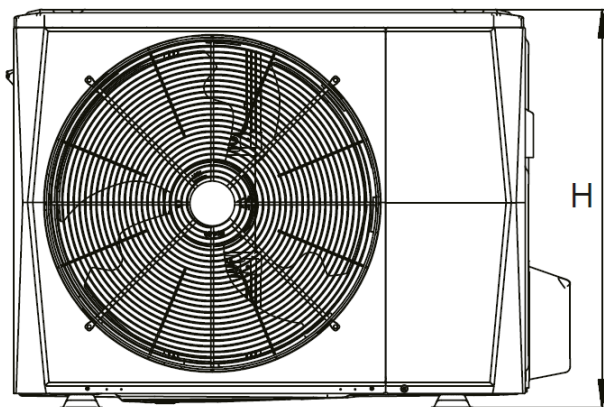

	A	B	C	D	E	F	G	H	I
mm	1008	375	426	663	134	110	170	712	160

Innengerät WMT6000i

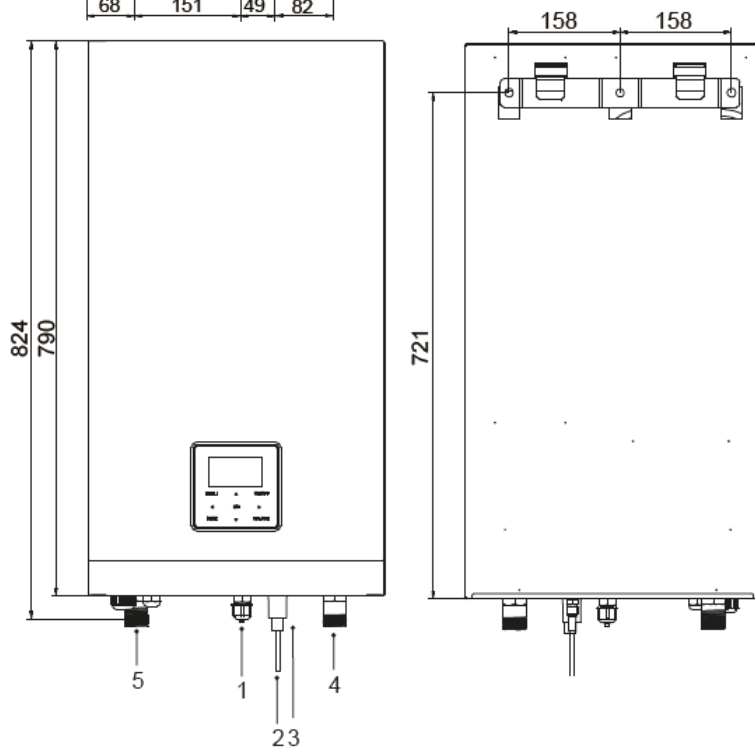
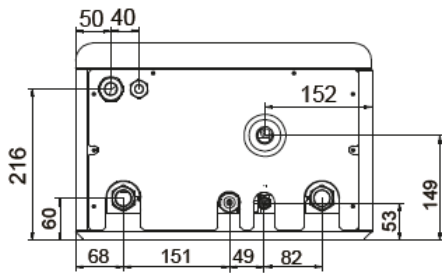

Masse: mm