

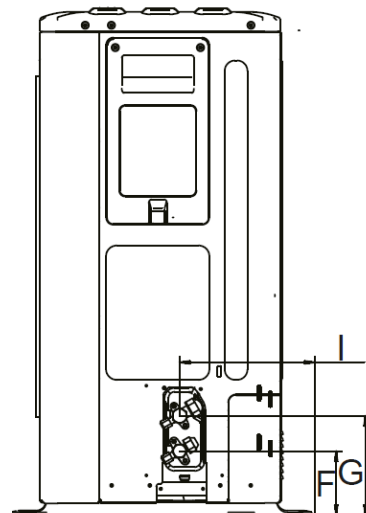

Luft- Wasser- Wärmepumpe Super Inverter WMT17000

Aussengerät WMT17000

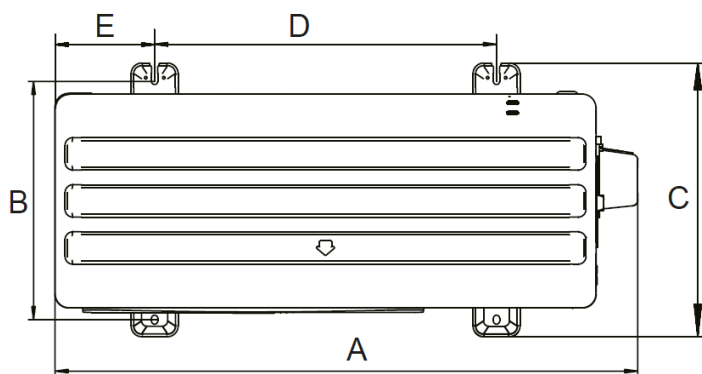
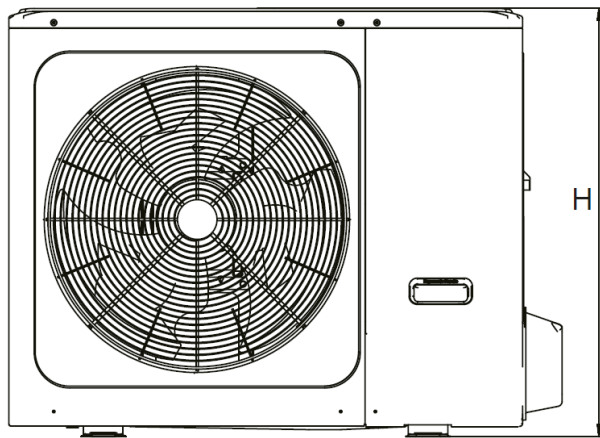

	A	B	C	D	E	F	G	H	I
mm	1118	456	523	656	191	110	170	865	230

Innengerät WMT17000i

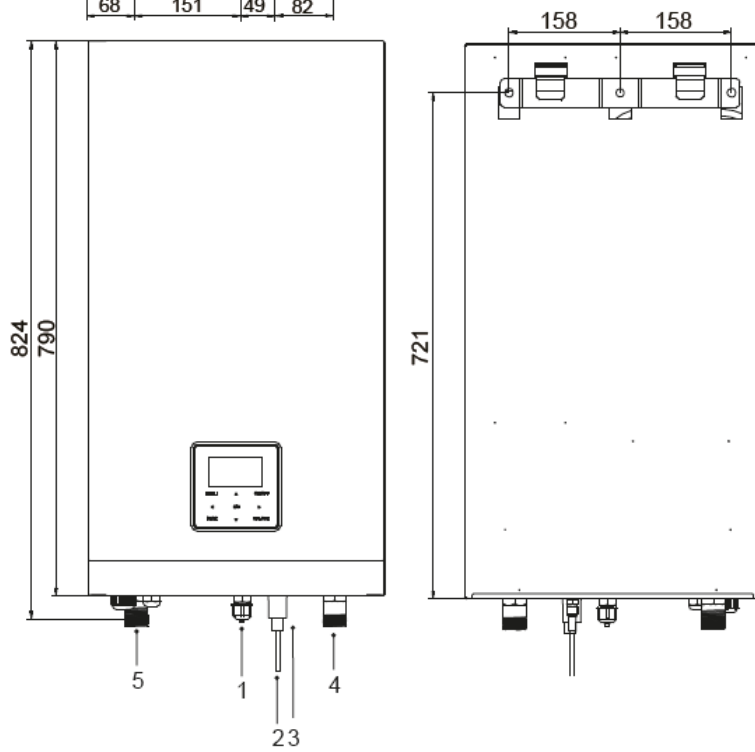
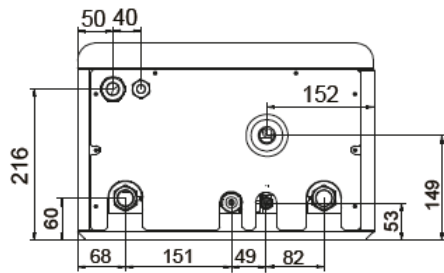
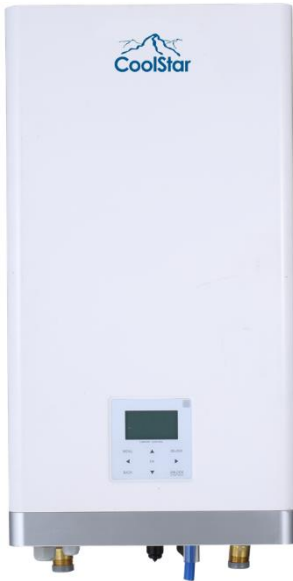

Masse: mm