



Inverter Split Klimagerät CoolStar CSD5300i

Decken- Truhengerät

Model: CSD5300i

Innengerät

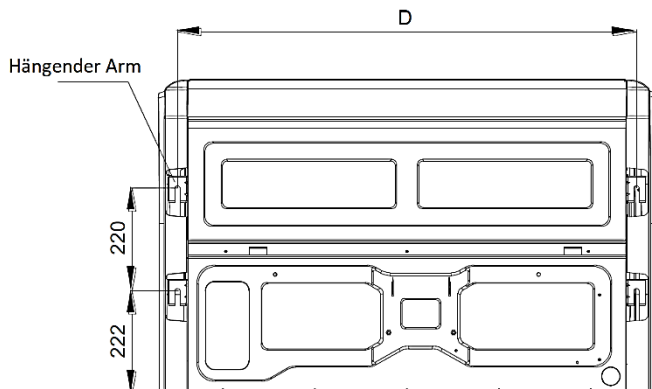
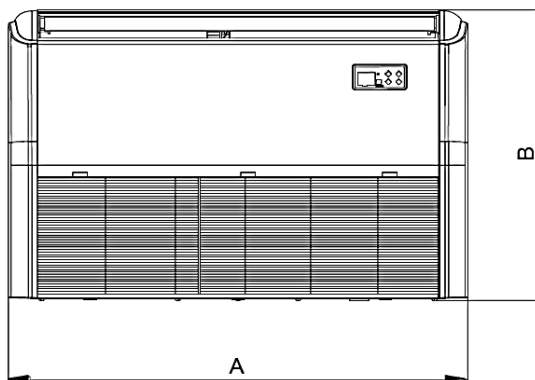
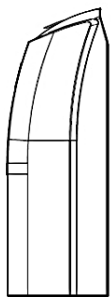
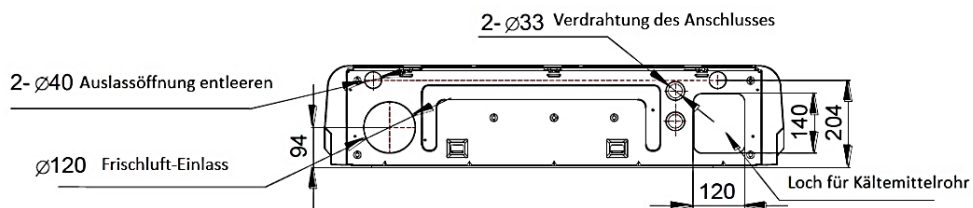

	Abmessungen
A	1068mm
B	675mm
C	235mm
D	983mm

Aussengerät

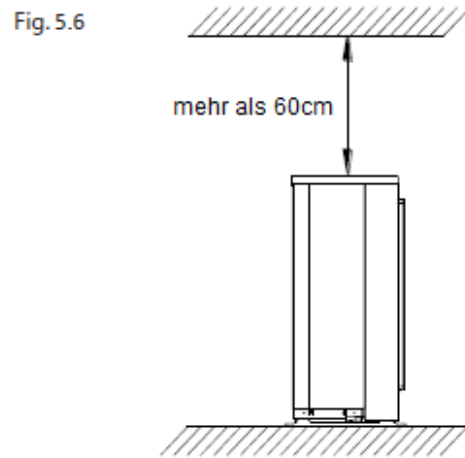
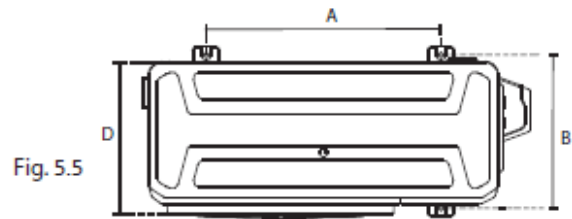
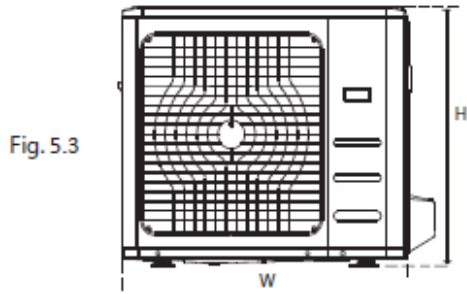

Abmessungen W x D x H	Montage-Abmessungen	
	Entfernung A	Entfernung B
800x333x554mm	514mm	340mm