



Inverter Split Klimagerät CoolStar CSD16000i

Decken- Truhengerät

Model: CSD16000i

Innengerät

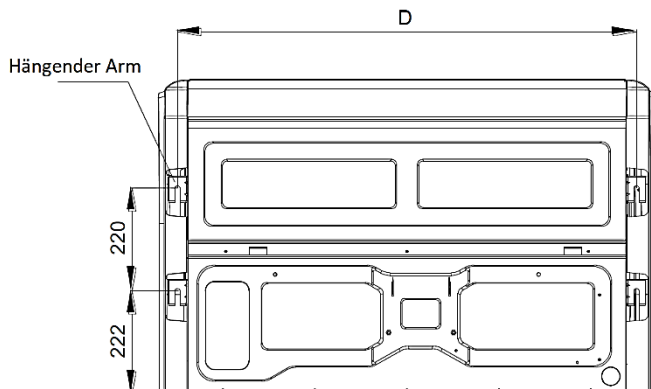
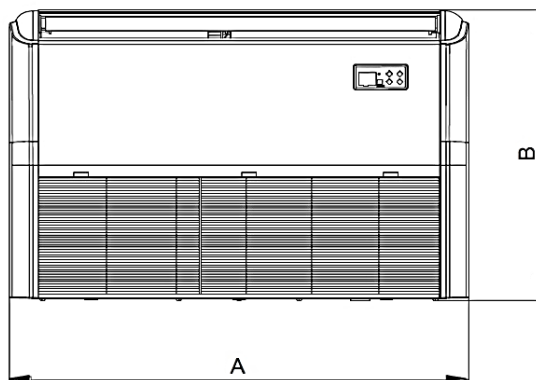
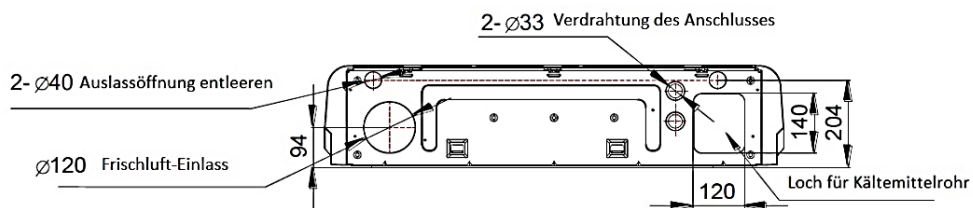

	Abmessungen
A	1650mm
B	675mm
C	235mm
D	1565mm

Aussengerät

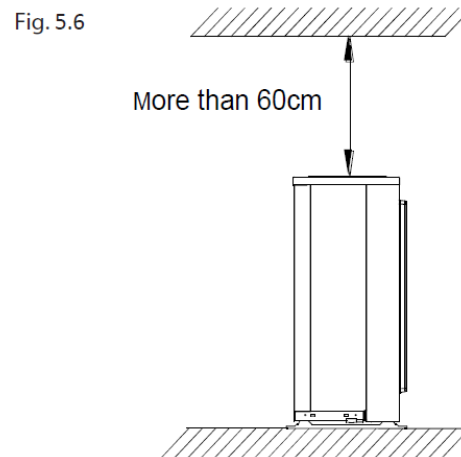
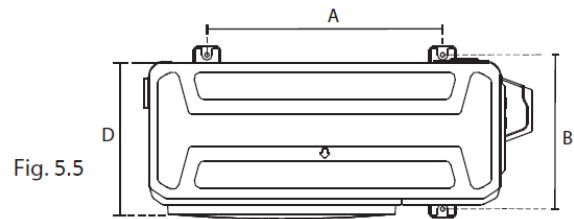
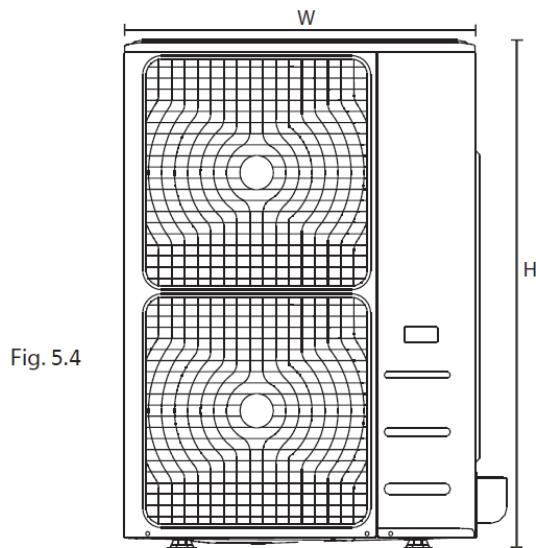

Abmessungen W x D x H	Montage-Abmessungen	
	Entfernung A	Entfernung B
952x415x1333mm	634mm	404mm