



Super Inverter Klimaanlage CoolStar CS6000invSE

Innengerät



Abmessungen (LxTxH) mm 965x215x319

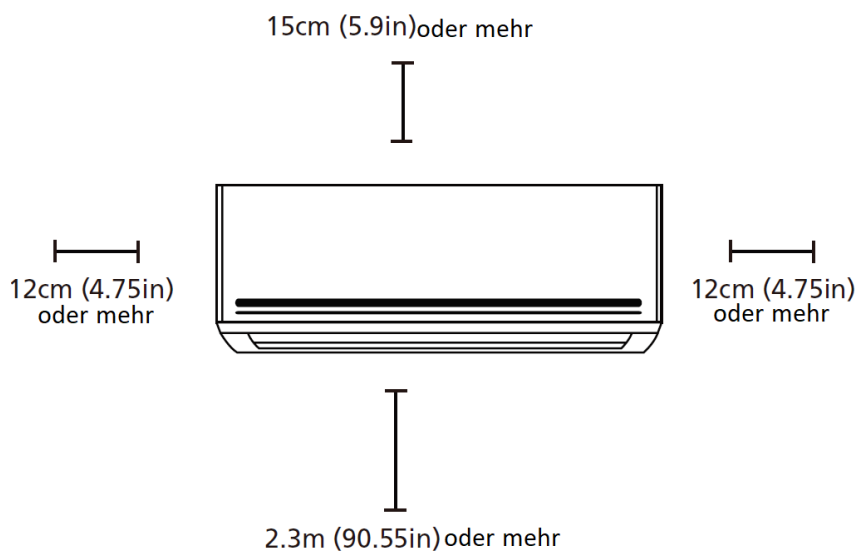

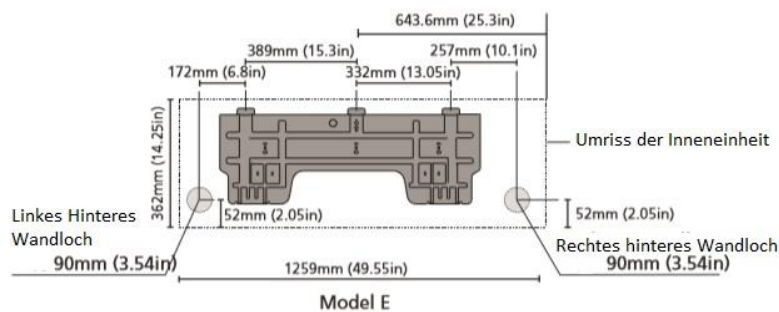
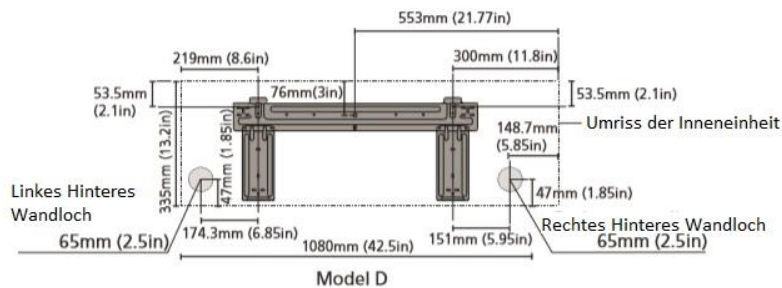
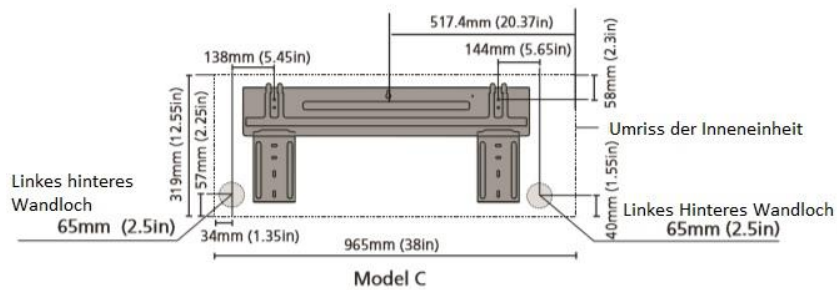
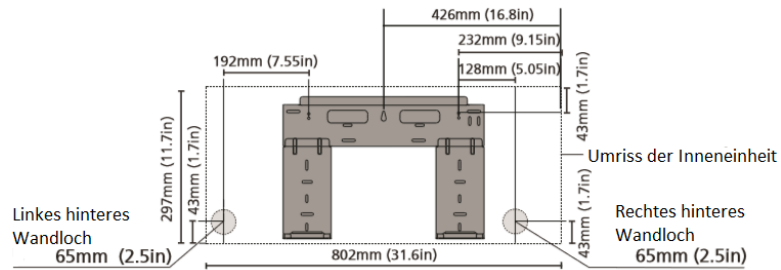
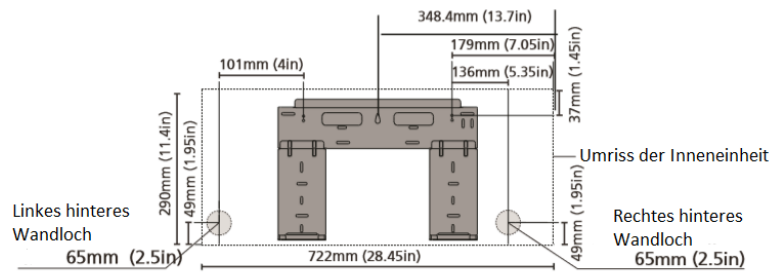

Aussengerät



Abmessungen (LxTxH)

mm

800x333x554

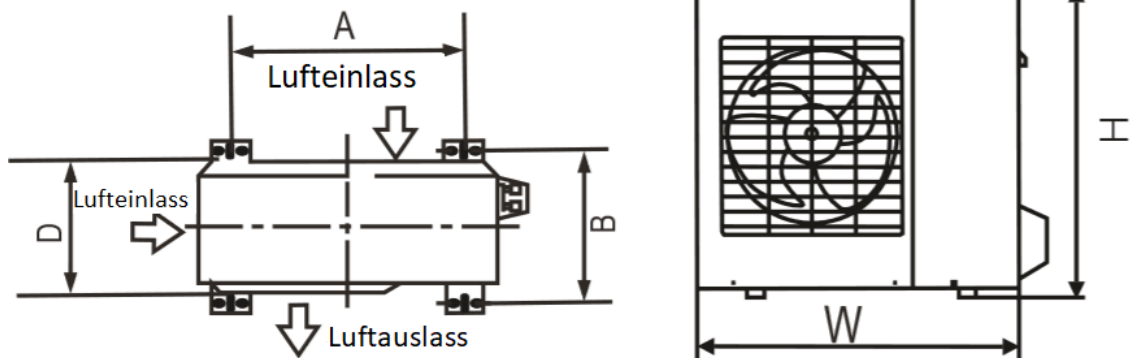

Fig. 4.5

Abstand A	mm	514
Abstand B	mm	340
D	mm	333
W	mm	800
H	mm	554